

Assembly Instructions: 2073-6, 2074-6 (Smyth)

IMPORTANT:

- ALL INSTALLATION WORK SHOULD BE DONE BY ACCREDITED PROFESSIONAL.
- SHUT OFF POWER SUPPLY AT FUSE OR CIRCUIT BREAKER!
- USE ONLY THE SPECIFIED BULBS. DO NOT EXCEED THE MAXIMUM WATTAGE!

For Customer Service, contact the place of purchase.

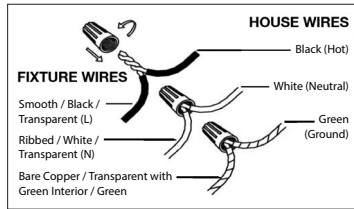

PREPARING FOR INSTALLATION

Please Note: The cage, and fixture body (R) are pre-assembled. Remove all of the contents from the carton. See the important notes above. Shut off the power at the circuit breaker and completely remove the old fixture from the ceiling, including the old mounting strap. From the parts bag remove the mounting strap assembly. One end of nipple (F) should be attached to mounting strap (A) with hex nuts (C, D) in place. The other end should have canopy loop (H) attached.

Match the threaded holes of mounting strap (A) to the spacing of the holes on the junction box. Attach mounting strap (A) to the junction box using mounting screws (B) and a screwdriver. Tighten securely. Unscrew canopy loop collar (I) from canopy loop (H). Pass canopy (G) over the mounted canopy loop to test the height. Approximately half of the canopy loop's exterior threads should be exposed, and the canopy loop collar should fit snugly onto the canopy loop. Remove canopy (G) and adjust the height of nipple (F) and canopy loop (H) until the desired height is reached.

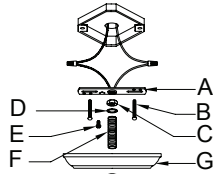

ASSEMBLING THE FIXTURE

Place fixture body (R) onto a flat surface. Rod (N) is on the fixture's wires, but not attached to the body of the fixture. Pass the fixture's wires through rod (N) and pull the wires until taut. Twist rod (N) onto the post at the center of the fixture body (R) until secure. By measuring, determine the correct number of chain links needed for proper hanging height. If necessary, use a pair of pliers to open and remove any excess chain. Attach one chain connector (K) to each end of chain (J). Use one of chain connectors (K) to attach chain (J) to top loop (L) and close the chain connector. Hook the end of rod (N) onto top loop (L). Pull the wires through top loop (L). Feed the fixture's wires up through the chain (every three links or so), pulling the wires until taut. Slide canopy loop collar (H) and canopy (G) onto the chain/wires. Use the free chain connector (K) to attach chain (J) to canopy loop (H).

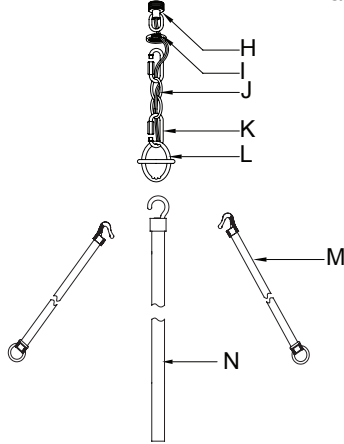

CONNECTING THE WIRES

Have an assistant support the fixture's weight while completing the wiring. Cut away excess wire. Thread the fixture's wires through canopy loop and nipple. Attach the fixture's wires to the power supply wires from the junction box. Connect black to smooth/black/transparent (L) wire; white to ribbed/white/transparent (N) wire; and ground to ground (green or copper). Twist the ends of the wire pairs together, and then twist on a wire connector. Make sure all twists are in the same direction. If there is no ground wire (green or copper) from the junction box, locate ground screw (E) on mounting strap (A) and wrap the fixture's ground wire around the green ground screw (E). Use a screwdriver to secure ground screw (E) onto the mounting bracket/mounting strap. Tuck all wires neatly into the junction box.

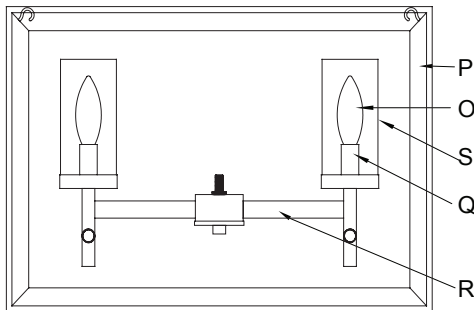

FINISHING THE INSTALLATION

Raise canopy (G) to the ceiling and slide canopy loop collar (I) up beneath the canopy. Tightly thread canopy loop collar (I) onto canopy loop (H) to secure canopy (G) in place.

Attach the hooks of rods (M) to top loop (L). Lift cage (P) up so that rods (M) and fixture body (R) is inside. Hold cage (P) up and have an assistant attach the bottom loops of rods (M) to the hooks inside cage (P). Do not let go of the cage until all rods are attached to cage (P). Slide candle sleeves (Q) over the sockets. Install light bulbs (O) (not included) in accordance with the fixture's specifications. Carefully slide glass shades (S) over candle sleeves (Q) and secure the glass in place by pushing the glass down onto the socket fitters.

Your installation is complete. Turn on the power and test the fixture.

CLEANING TIPS

Treat the fixture gently! Regular cleaning will reduce the need for deep cleaning. For regular cleaning, turn off the light and wipe down the fixture with a clean lint-free cotton or microfiber cloth. Never spray cleaner directly onto the fixture. For deep cleaning, turn off the light and remove the glass prior to cleaning. Hand wash glass with warm water and mild detergent. Dry with a lint-free or microfiber cloth.